

CABINET WITH 2 HINGED DOORS AND 6 BOX
SHELVES WITH TRANSPARENT POLYCARBONATE
LID, DIM. 1400X800X2400+300Hmm

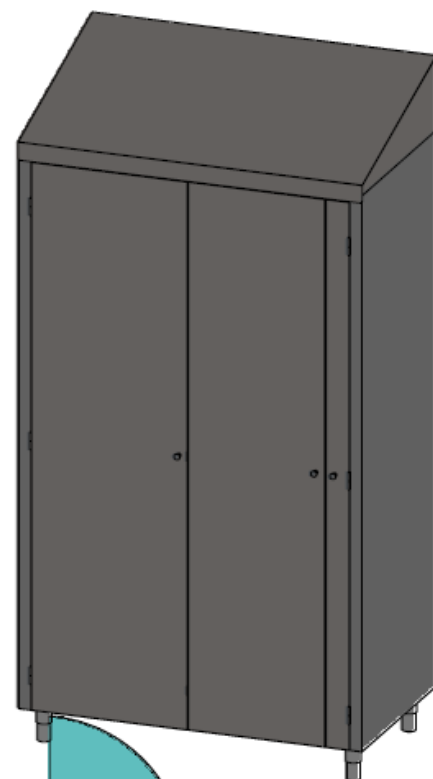

Made of AISI 304 Ni-Cr 18/10 stainless steel with Scotch Brite finish. Hinged doors mounted on hygienic hinges removable without the use of mechanical tools, with magnet closure. Complete with no. 6 box shelves H=300mm, complete with hinged lid in transparent polycarbonate. Space between each shelf 50mm. Prepared for wall mounting. On adjustable feet, the rear ones 80mm advances for rounded floor corner. Anti-dust inclined roof H=300mm.

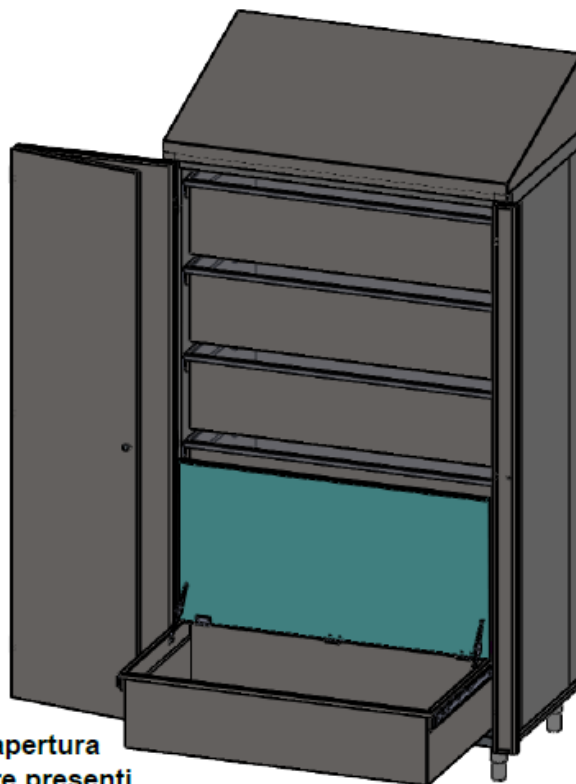
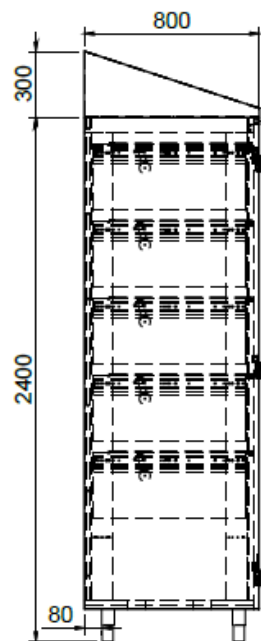
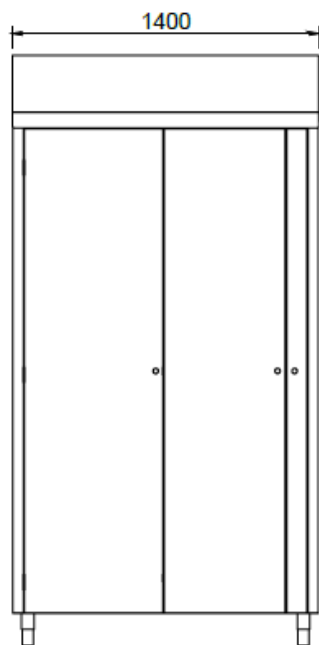

nuove ante con doppia apertura
con utilizzo delle cerniere presenti

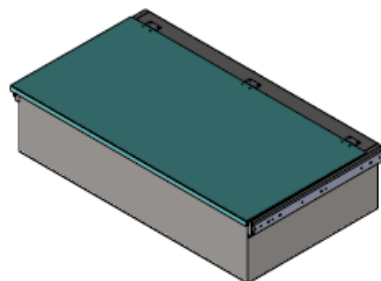
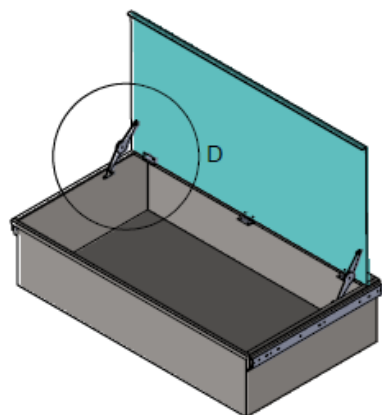

sistema di supporto
a compasso

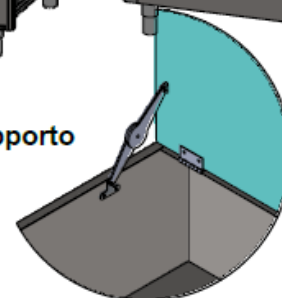

DETTAGLIO D
SCALA 2 : 25



Tolleranza generale: dimensioni:	UNI ISO 2768-mk		Scala:	1:30	Peso:	424,694 kg
			Materiale:			
			Sviluppo:		x x	
			Trattamento:			

Serie:	Codice articolo:	Codice cliente:
Descrizione: ARMADIO CON 2 ANTE BATTENTI E 6 RIPIANI A VASCHETTA SU GUIDE TELESCOPICHE ESTRAIBILI CON COPERCHIO IN LEXAN TRASPARENTE, DIM. 1400X800X2400+300h/mm		Codice: TS22000341-000A
		Rev.